

Pin Assignments	
Pin #	Description
1	P-Anode
2	F-Fast Output
3	N-Cathode
4	No Connect

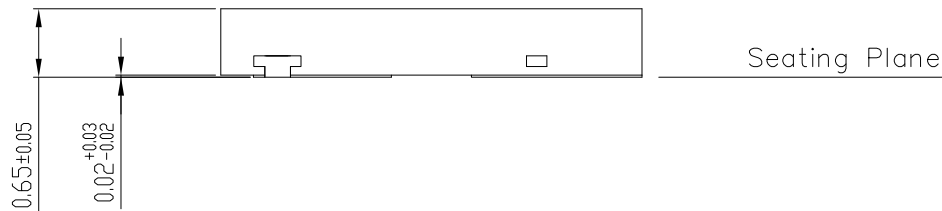

DATE	26 June 2017	REVISION	D	SCALE	20 : 1
SensL Technologies Ltd					Sheet
www.sensl.com					1 of 6
DWG. NO:	SNDO173	DO NOT SCALE	ALL DIMENSIONS IN MM		
TITLE:					
MicroFC-300xx-SMT-C1					
PROJECTION:					

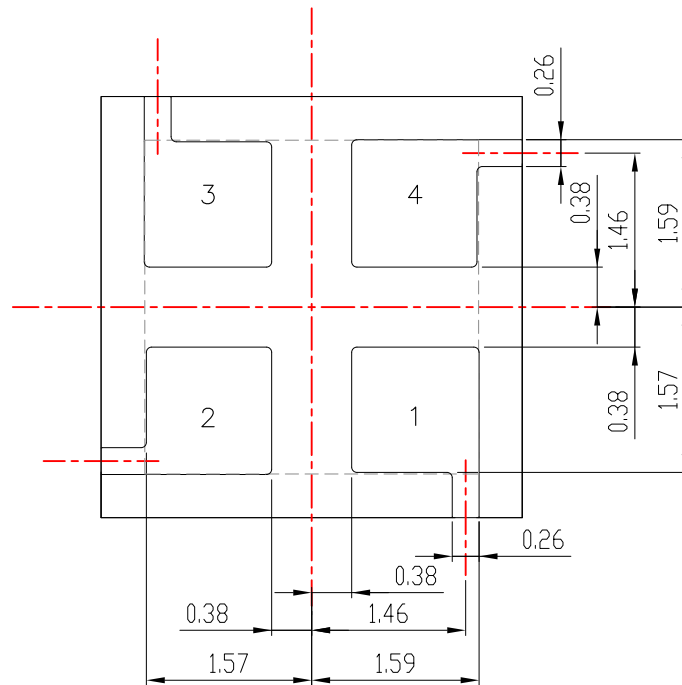
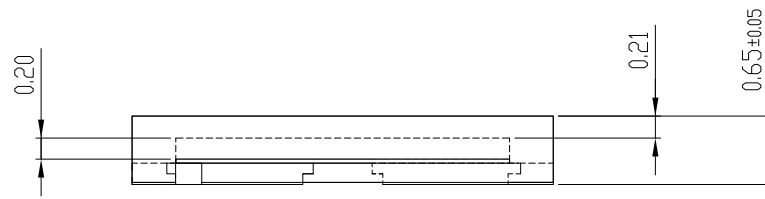

Bottom View Scale: 20 : 1

Pin Assignments

Pin #	Description
1	P-Anode
2	F-Fast Output
3	N-Cathode
4	No Connect

DATE	26 June 2017	REVISION	D	SCALE:	20 : 1
SensL Technologies Ltd				Sheet	
www.sensl.com				2 of 6	
DWG. NO:	SND0173	DO NOT SCALE	ALL DIMENSIONS IN MM		
TITLE:					
MicroFC-300xx-SMT-C1					
PROJECTION:					

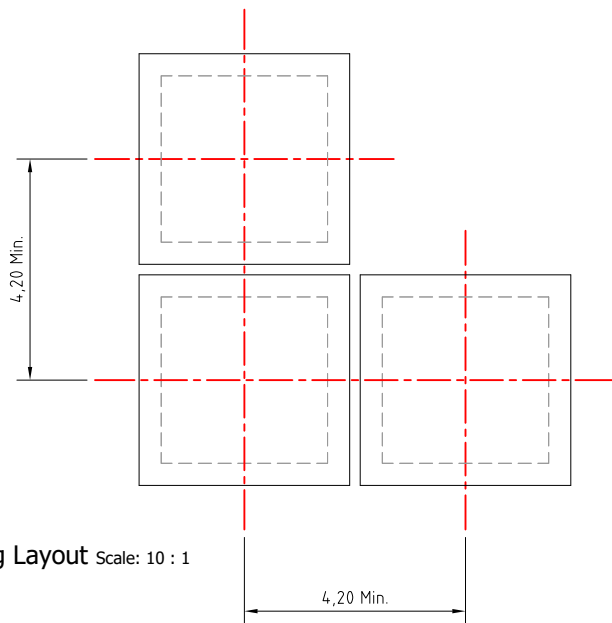

NOTE: Alignment and placement tolerances depend on the accuracy of the equipment used in the assembly process.

DATE	26 June 2017	REVISION	D	SCALE:	10 : 1
SensL Technologies Ltd www.sensl.com				Sheet	3 of 6
DWG. NO:	SNDO173	DO NOT SCALE	ALL DIMENSIONS IN MM		
TITLE: MicroFC-300xx-SMT-C1					
PROJECTION:					

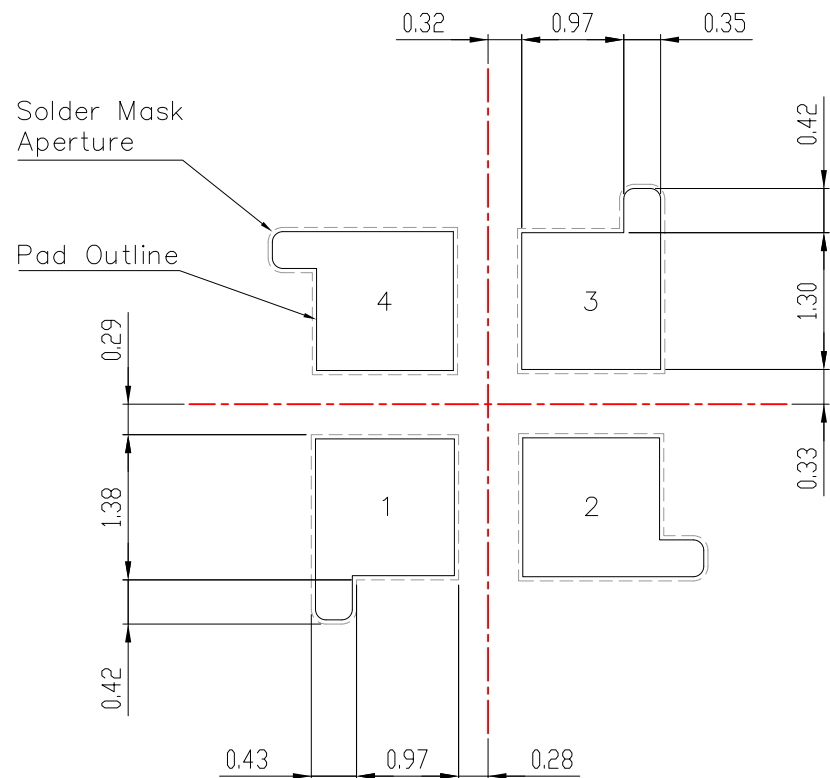

Recommended PCB Solder Footprint

Scale: 20 : 1

NOTE: No Connect (NC) pin 4 should be soldered to PCB, this pin can be connected to ground but it can also be left floating without affecting the dark noise.

DATE	26 June 2017	REVISION	D	SCALE:	20 : 1
SensL Technologies Ltd					Sheet
www.sensl.com					4 of 6
DWG. NO:	SND0173	DO NOT SCALE ALL DIMENSIONS IN MM			
TITLE:					
MicroFC-300xx-SMT-C1					
PROJECTION					

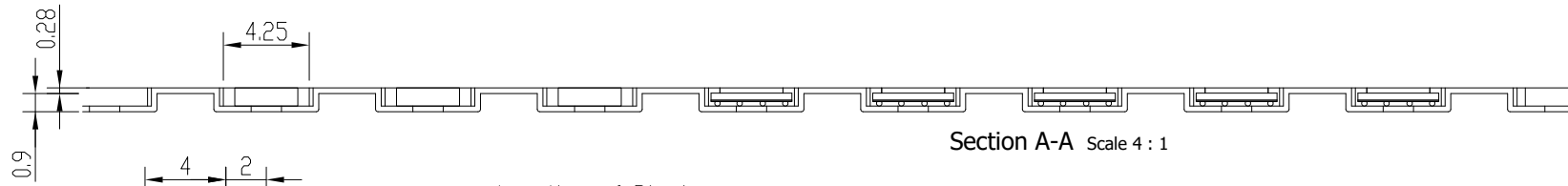

Section A-A Scale 4 : 1

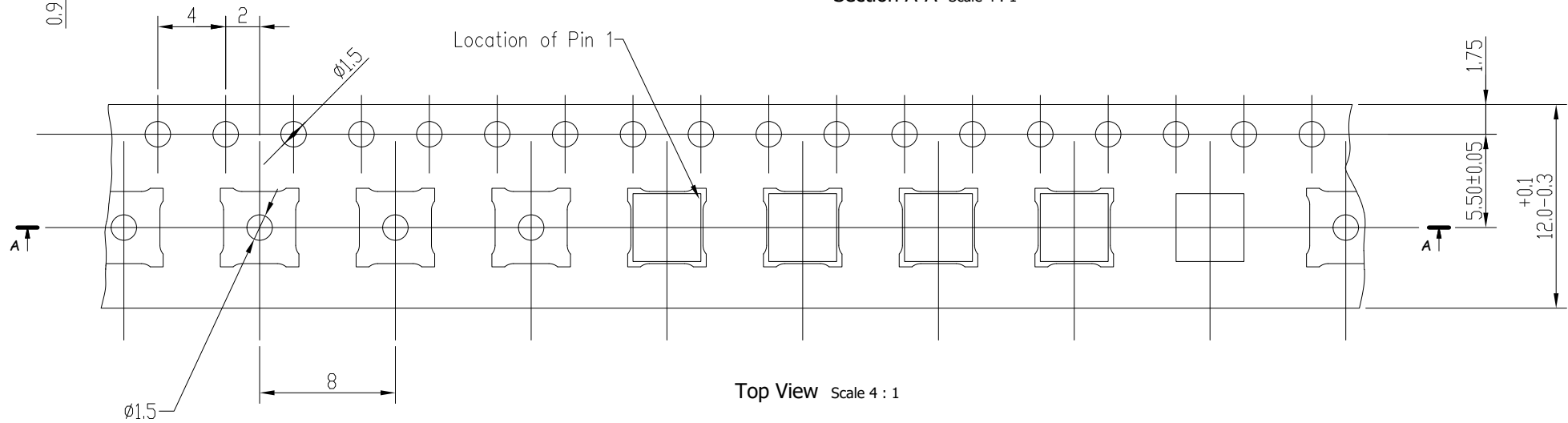

Top View Scale 4 : 1

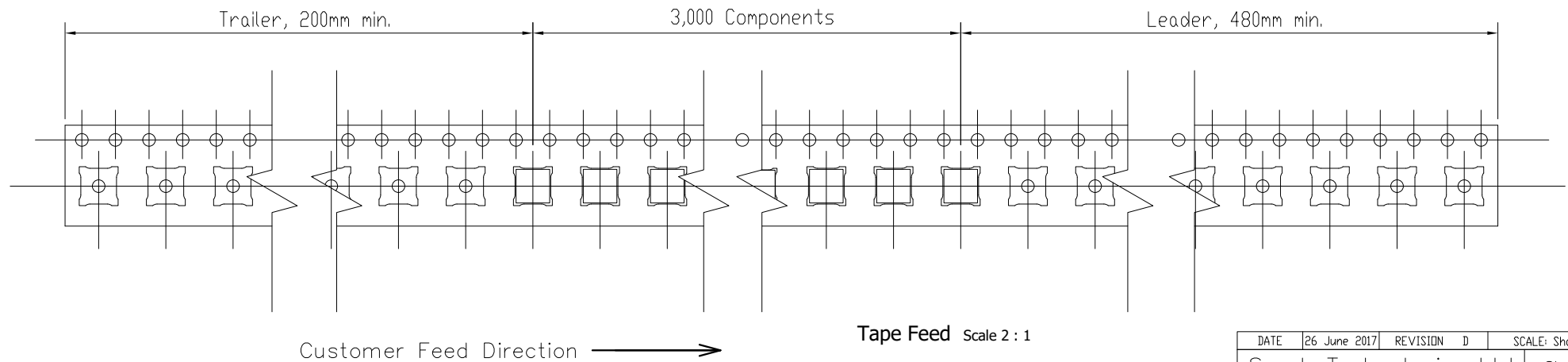

Tape Feed Scale 2 : 1

All Dimensions $\pm 0.1\text{mm}$ Unless Otherwise Stated

DATE	26 June 2017	REVISION	D	SCALE: Shown
SensL Technologies Ltd				Sheet
www.sensl.com				5 of 6
DWG. NO:	SND0173	DO NOT SCALE	ALL DIMENSIONS IN MM	
TITLE:				
MicroFC-300xx-SMT-C1				
PROJECTION:				

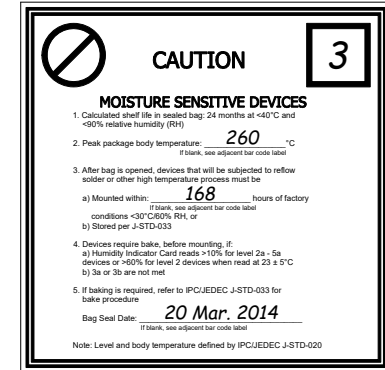
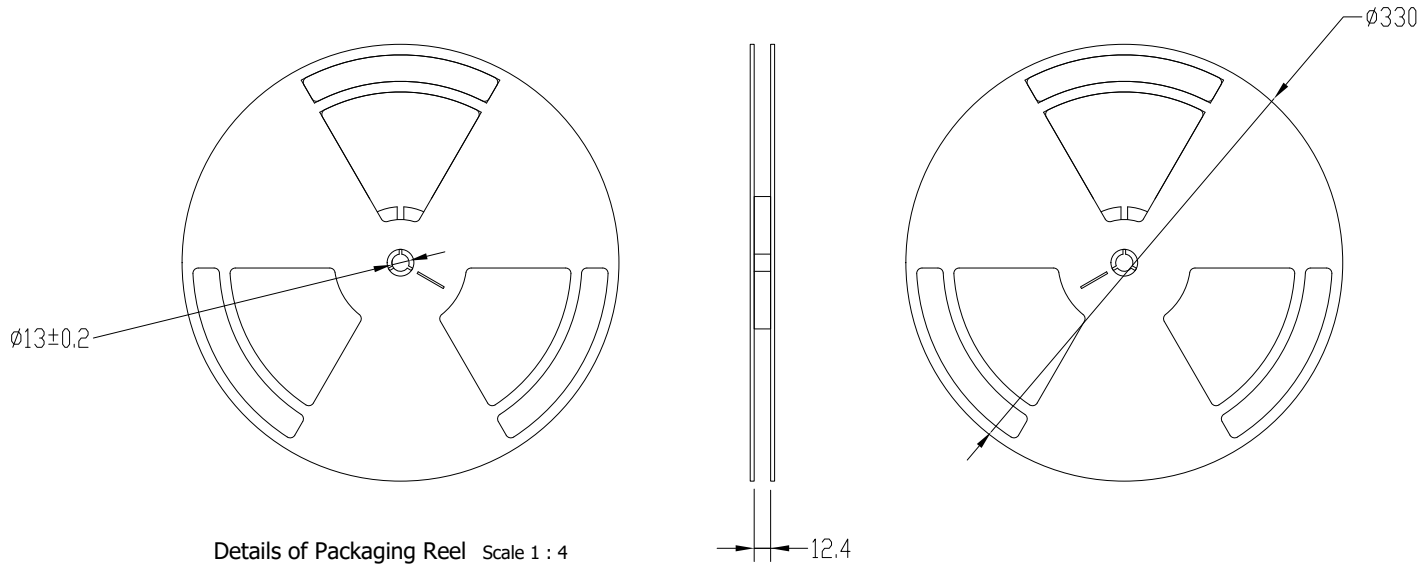

Details of Moisture Sensitivity Label

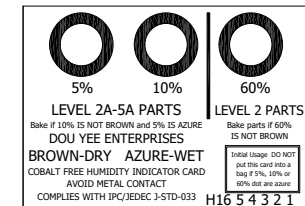
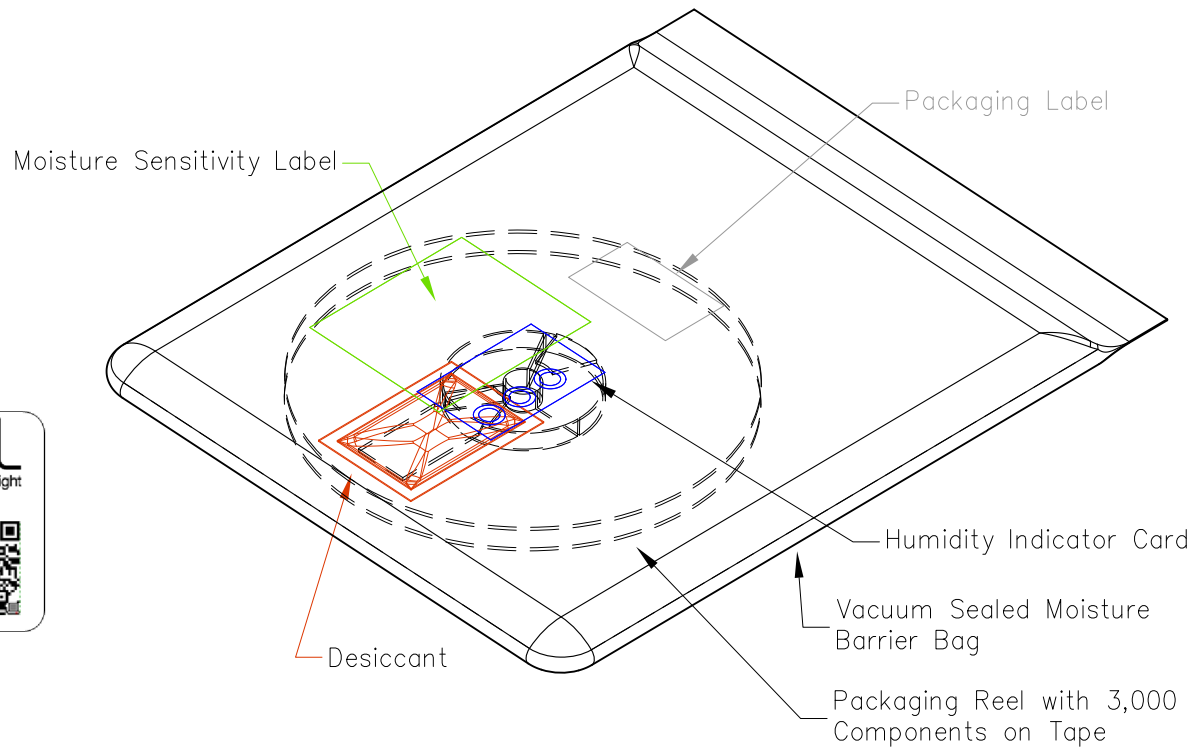

Humidity Indicator Card

sensl
sense light

Part#: MICROFC-30035-SMT
Revision: C1
Lot#: E1234-35
Lot#
Quantity: 3000

Sample Packaging Label

DATE	26 June 2017	REVISION	D	SCALE:	Shown
SensL Technologies Ltd				Sheet 6 of 6	
www.sensl.com					
DWG. NO:	SND0173	DO NOT SCALE ALL DIMENSIONS IN MM			
TITLE: MicroFC-300xx-SMT-C1					
PROJECTION:			sensl sense light		